

Evian Mind Display - Assembly Instructions

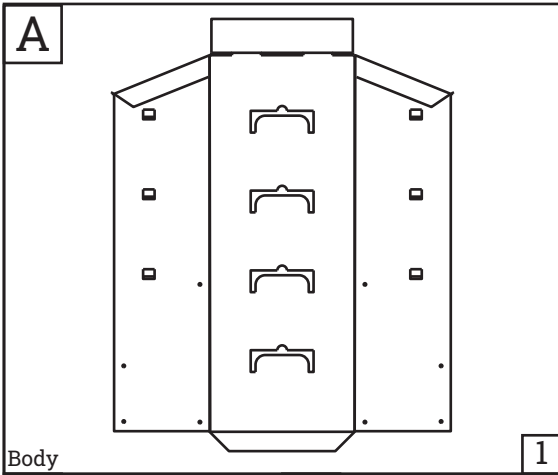

▶ Scan the QR code or visit the web address directly to view the assembly video: displaybuilds.com/instructions_18187



Body 1

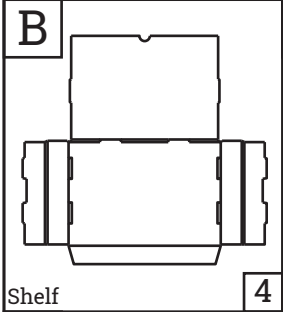

Shelf 4

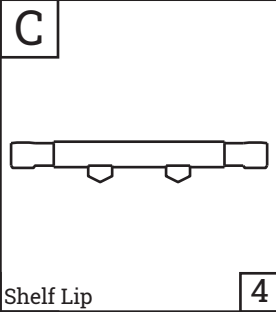

Shelf Lip 4

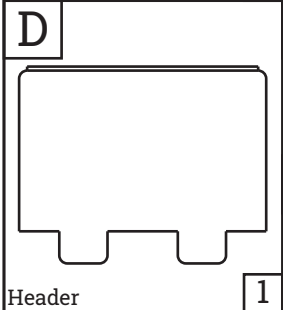

Header 1

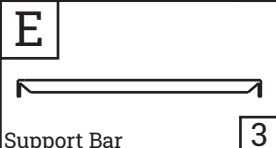

Support Bar 3

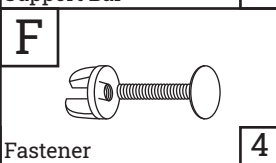

Fastener 4

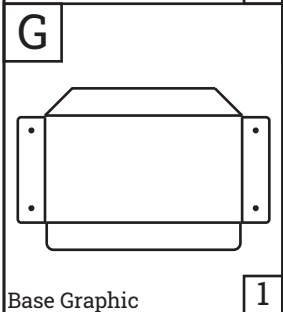

Base Graphic 1

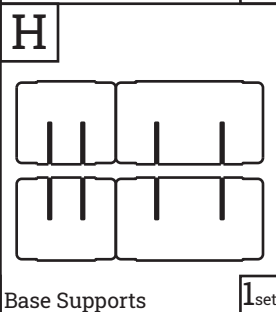

Base Supports 1 set

1 SHELF ASSEMBLY

1. Fold large bottom of (B) Shelf over.
2. Fold side and bottom tabs inward on (C) Shelf Lip.
3. Insert tabs on bottom of (C) Shelf Lip into front of (B) Shelf.
4. Fold the sides of the (B) Shelf over the side tabs on the (C) Shelf Lip. Repeat to assemble all shelves.

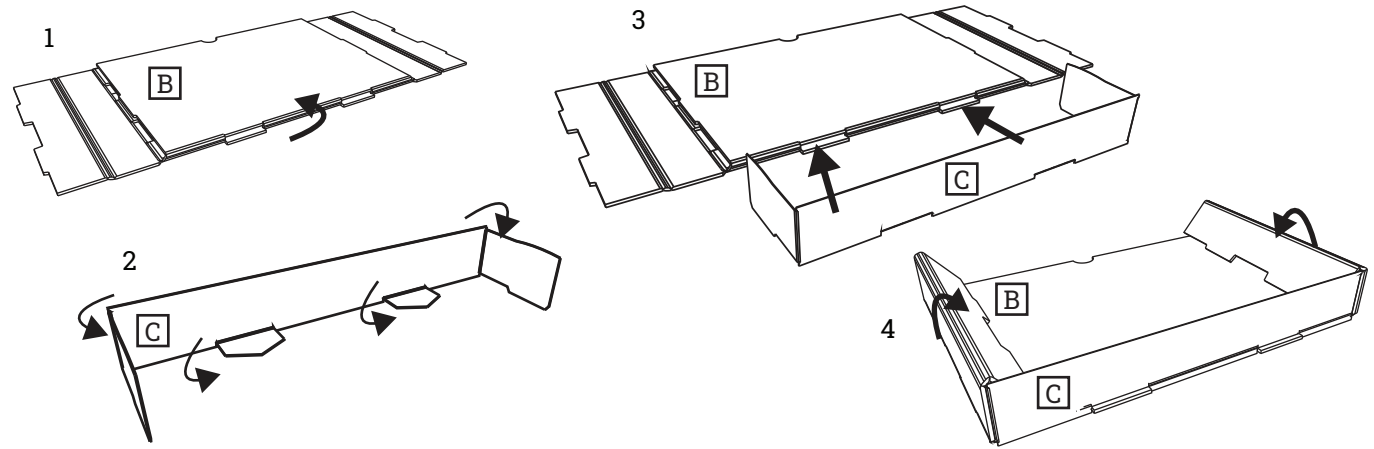

2 Square up display (A) Body, fold tabs inward, and secure with provided tape.

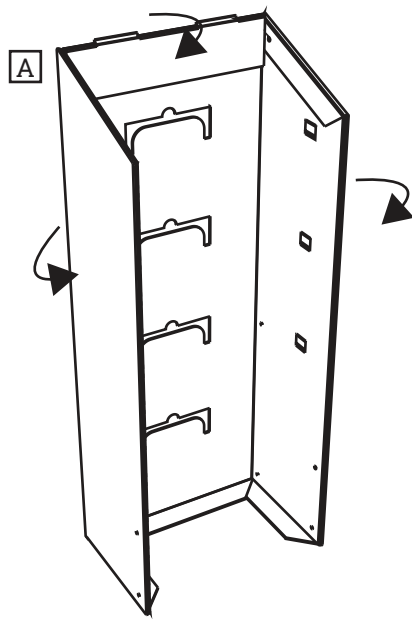

3 Attach (G) Base Graphic with (F) Fasteners.

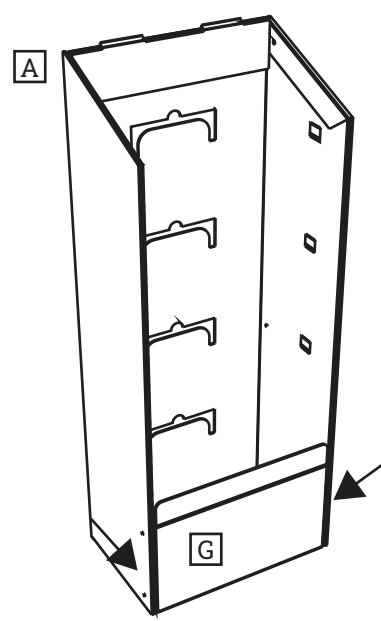

4 Interlock pieces of (H) Base Supports as shown and place in the bottom of the display, behind the (G) Base Graphic.

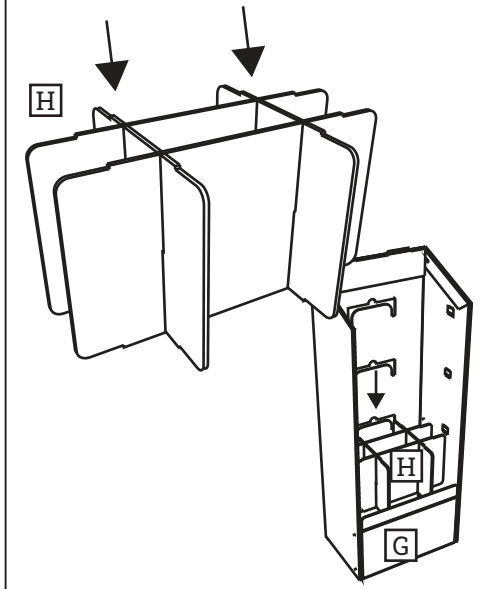

Scan the QR code or visit the web address directly to view the assembly video: displaybuilds.com/instructions_18187



5 Insert (E) Support Bars at each location as indicated.

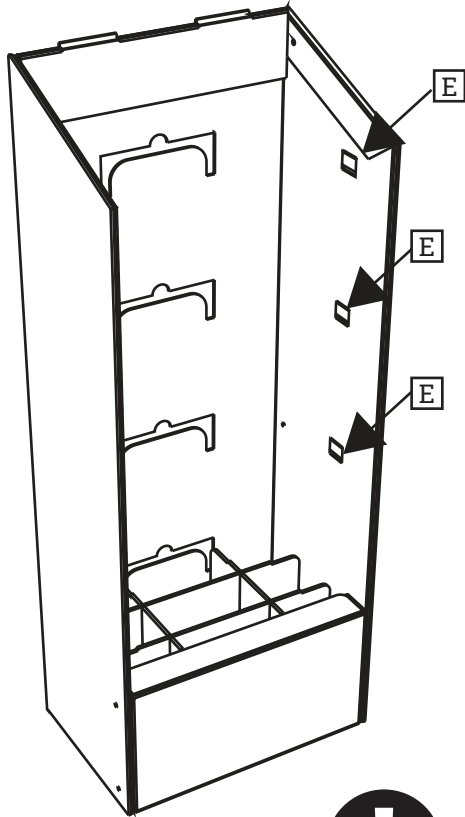

6 Install assembled (B) Shelves by inserting the tab at the back down into the tab at the back of the (A) Body. BE CAUTIOUS NOT TO FOLD OR BEND THE TAB ON THE BODY. Rest the front of the shelf on the (E) Support Bar.

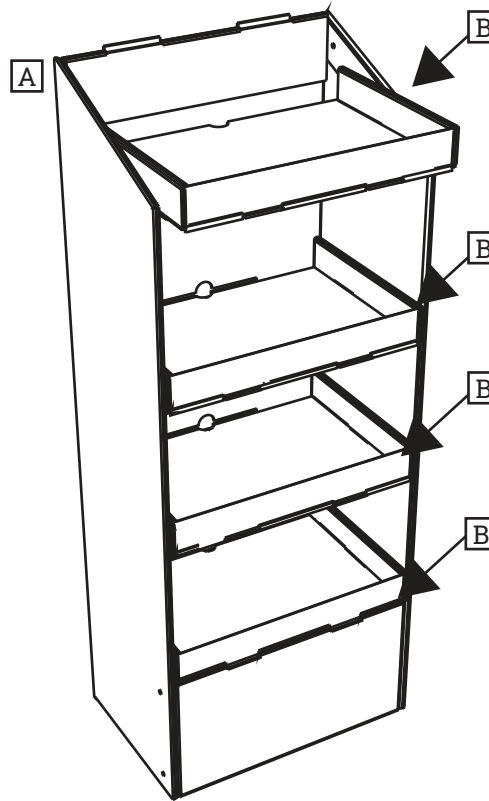

7 Insert (D) Header to complete assembly.

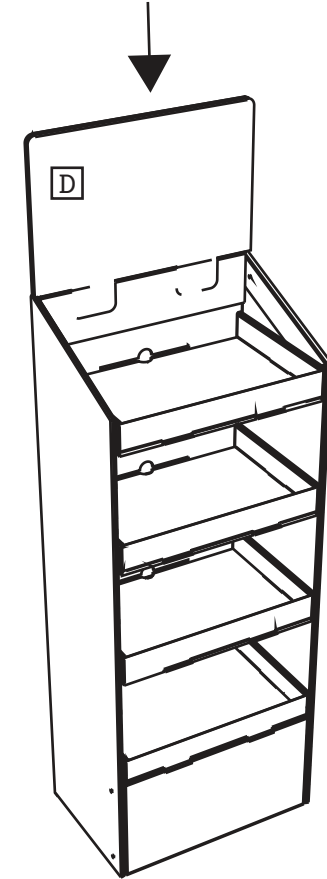

MISSING PARTS / DAMAGE CLAIM INSTRUCTIONS

1. DO NOT discard the box or original packaging.
In the case of damaged goods caused by shipping, photo evidence will be required.
2. Take photos of the box & markings.
A photo of the markings (text) on the side of the box is required for all cases in which a replacement part is needed. This helps to identify the item number and ensures the correct parts are pulled.
3. Take photos of damage (if applicable).
A photo of the damaged part(s) is always required to file a claim and expediently process the replacement part. Please make sure you keep the box even if it is damaged.
4. Send an email with the images requested.
Email a description of the claim along with the images required above at displaybuilds.com/contact or directly to help@displaybuilds.com. Call our toll-free number 1-866-308-8368 for further assistance.